

CODE NUMBER

3370038

DESCRIPTION

1.5 gpf, Polished Chrome Finish, Top Spud, Single Flush, Solar, SOLIS® Exposed Sensor Urinal Flushometer.

DETAILS

- Flush Volume: 1.5 gpf (5.7 Lpf)
- Finish: Polished Chrome (CP)
- Power Type: Solar
- Battery Life: 6 years
- Valve: Diaphragm
- Valve Body Material: Semi-red Brass
- Fixture Type: Urinal
- Fixture Connection: Top Spud
- Rough-In Dimension: 11 ½" (292mm)
- Spud Coupling: 1 ¼" (32mm)
- Supply Pipe: 1" (25mm)

FEATURES

- Handle Packing, Main Seat, Stop Seat and Vacuum Breaker Molded from PERMEX® Rubber Compound for Chloramine resistance
- User-friendly, three-second flush delay and Courtesy Flush™ override button
- "Low Battery" Flashing LED
- Sweat solder adapter with cover tube and cast wall flange with set screw
- Solar Powered. The sensor assembly is powered by a solar cell that will harvest power from the artificial indoor light (incandescent, fluorescent or LED), and use it as the energy source. The solar cell can provide approximately 100% power with 650 illuminance (lux).
- Four (4) Size AA Battery Back-up Power Source
- Synthetic rubber seals for chloramine resistance
- Infrared Sensor with Multiple-focused, Lobular Sensing Fields for high and low target detection
- Fixed metering bypass and no external volume adjustment to ensure water conservation
- Fixed Metering Bypass and No External Volume Adjustment to Ensure Water Conservation
- Engineered Metal Cover with replaceable Lens Window
- ADA Compliant Sloan Solis® Solar Powered Infrared Sensor for automatic "No Hands" operation
- 1" IPS screwdriver Bak-Chek® angle stop with vandal resistant stop cap
- User-friendly, three-second flush delay and Courtesy Flush® override button
- High Copper, low zinc brass castings for dezincification resistance
- Valve body, Cover, Tailpiece and Control Stop shall be in compliance with ASTM Alloy Classification for Semi-Red Brass
- Valve shall be in compliance to the applicable sections of ASSE 1037

**COMPLIANCES & CERTIFICATIONS**

(ADA Compliant, cUPC Certified, BAA Compliant)

RECOMMENDED SPECIFICATION

Valve Body, Cover, Tailpiece and Control Stop shall be in conformance with ASTM Alloy Classification for Semi- Red Brass. Valve shall be in compliance with the applicable sections of ASSE 1037 and ANSI/ASME 112.19.2.

ELECTRICAL SPECIFICATIONS

- Battery Life: 6 years

VALVE OPERATING PRESSURE (FLOWING)

15-80 PSI (103-552 kPa). Specific fixtures may require greater minimum flowing pressure - consult manufacturer requirements.

DOWNLOADS

- [Solis 8100 Series Installation Instructions](#)
- [Solis 8100 Series \(Spanish\) Installation Instructions](#)
- [Control Stop Repair and Maintenance Guide](#)
- [Flush Connections Flanges Repair and Maintenance Guide](#)
- [Tail Piece Repair and Maintenance Guide](#)
- [Concealed Solis Repair and Maintenance Guide](#)
- [Additional Downloads](#)

NOTES

All information contained within this document subject to change without notice.

Looking for other variations of the SOLIS 8180 product? [View the general spec sheet with all options.](#)

[Find a compatible urinal](#) for this flushometer.

[Find a compatible water closet](#) for this flushometer.

Sloan 10500 Seymour Ave, Franklin Park, IL 60131

Phone: 800.982.5839 • Fax: 800.447.8329 • sloan.com

ROUGH-IN

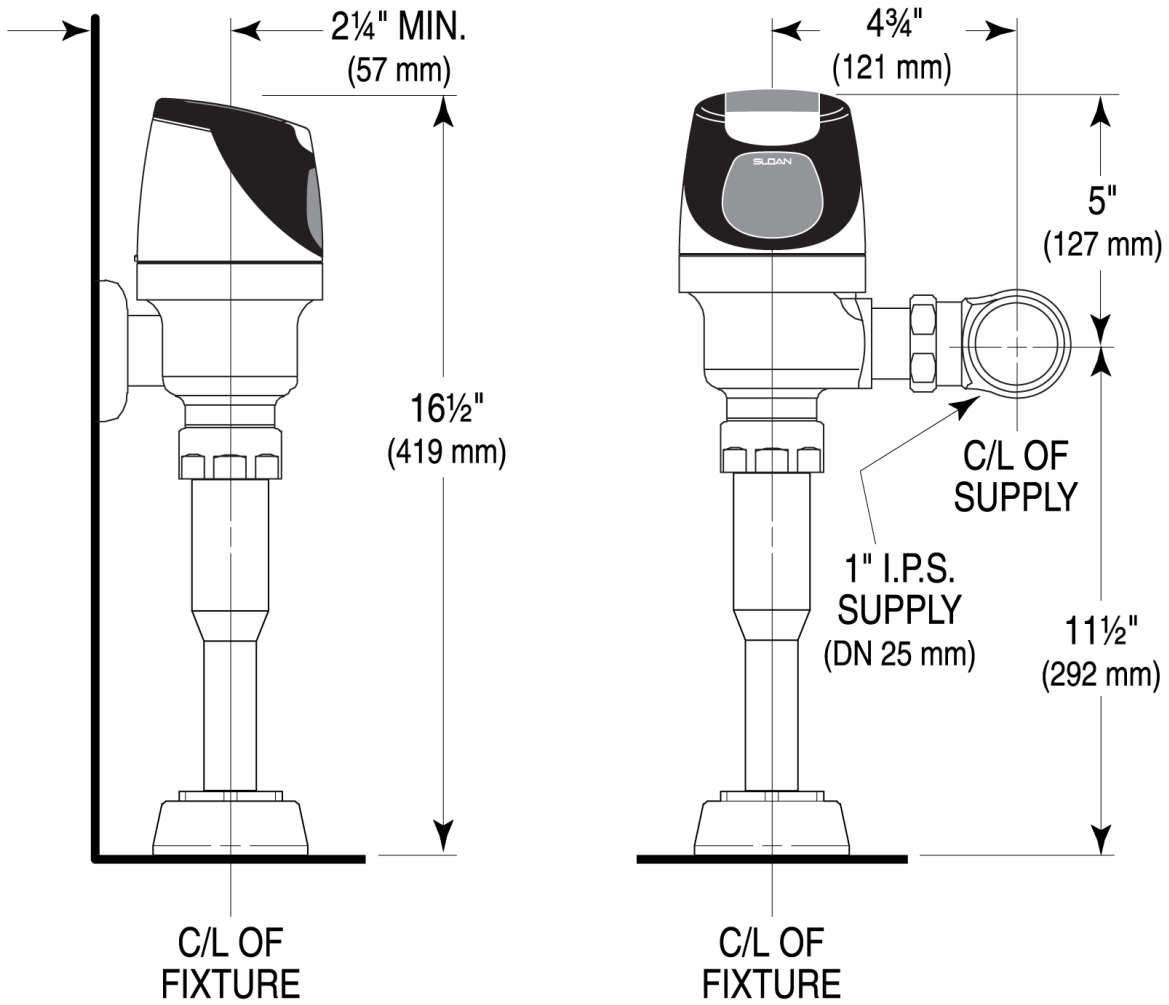

Sloan 10500 Seymour Ave, Franklin Park, IL 60131
Phone: 800.982.5839 • Fax: 800.447.8329 • sloan.com